

Matter Over Thread CCT LED Controller

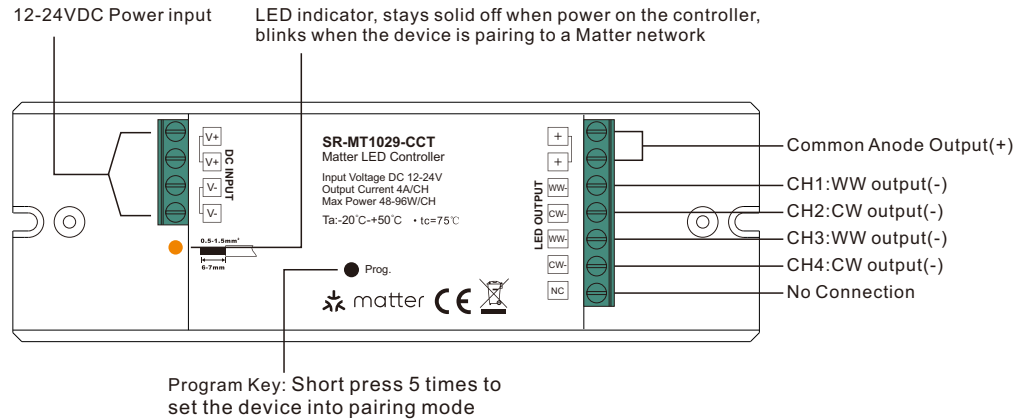

Important: Read All Instructions Prior to Installation

Function introduction



Product Data

Input Voltage	Output Current	Output Power	Remarks	Size(LxWxH)	Ambient Temperature	Max. Casing Temperature
12-24VDC	4A/CH	48-96W/CH	Constant voltage	145x46.5x16mm	-20°C ~ +50°C	75°C

Product Features

- Matter over thread CCT LED controller
- Matter certified device
- Communication via an IPv6 Thread Network
- App control through Matter (e.g. Apple Home, Amazon Alexa, Google Home)
- Controls tunable white LED lights
- Fully compatible with universal Matter ecosystems from different manufacturers
- Thread Border Router is required (e.g. Apple HomePod mini or Google NestHub)
- Easy commissioning and pairing by scanning the QR code
- Can be voice controlled through Apple Siri, Google Assistant, Amazon Alexa
- Eliminates the shortcoming of Matter having few remote and wall switch devices
- Wireless firmware updates possible
- Waterproof grade: IP20

Safety & Warnings

- DO NOT install with power applied to device.
- DO NOT expose the device to moisture.

Operation

1. Do wiring according to connection diagram correctly.
2. This Matter thread device is a wireless receiver that communicates with a variety of Matter compatible systems. This receiver receives and is controlled by wireless radio signals from the compatible Matter system.
3. Add to a Matter border router and control through the Matter platform:

Note: an Apple HomePod mini is used as a Matter border router for adding and controlling the device. For other Matter border routers, please refer to their user manuals to learn how to add and control Matter devices.

Step 1: Prepare an iPhone (iOS 16.2 or later) or iPad (iPadOS 16.2 or later) with the latest version firmware, and prepare an Apple HomePod mini with the latest version firmware.

Step 2: Connect the iPhone or iPad to your home WLAN network. Run the Apple Home app and set up the HomePod mini as instructed by Apple (as shown in Figure 1 to Figure 7).

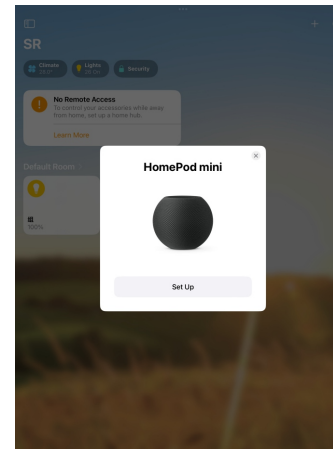

Figure 1

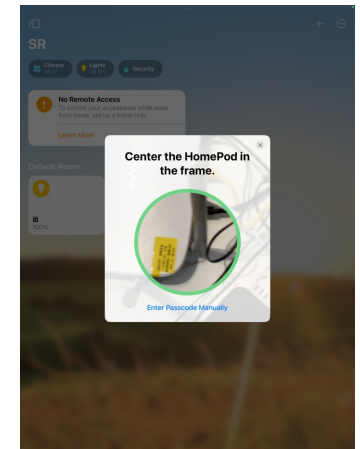

Figure 2

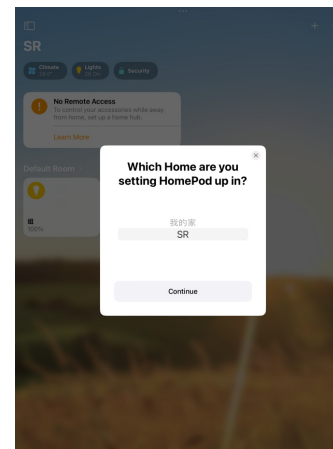

Figure 3

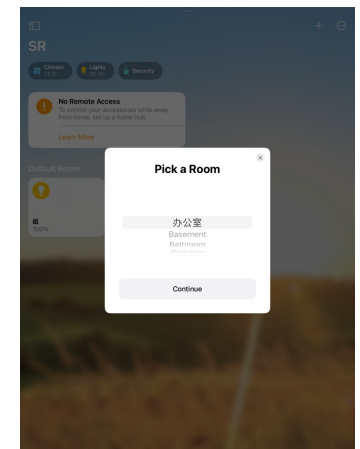

Figure 4

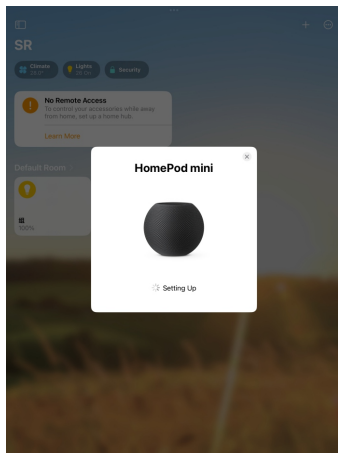

Figure 5

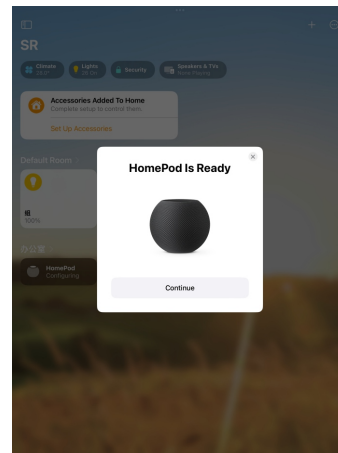

Figure 6

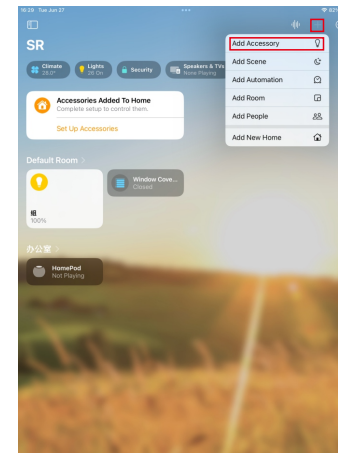

Figure 8

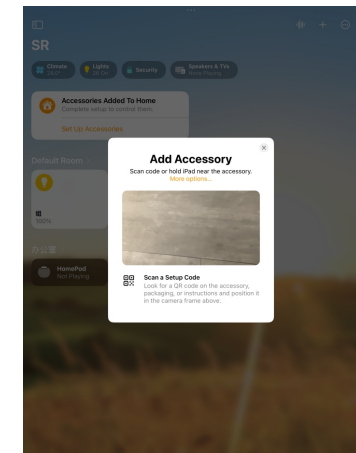

Figure 9

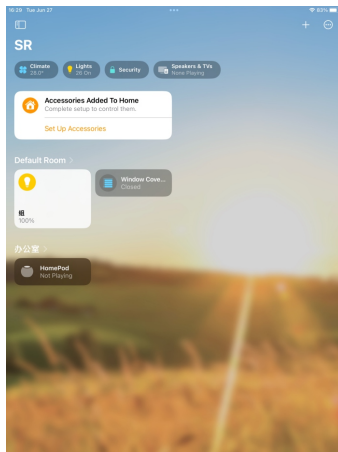

Figure 7

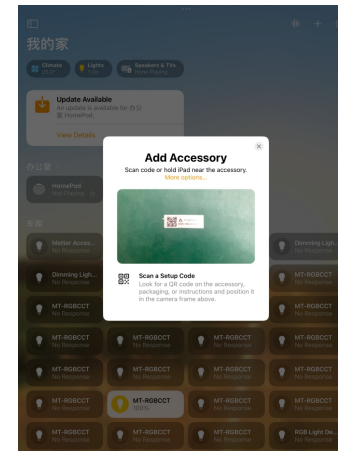

Figure 10

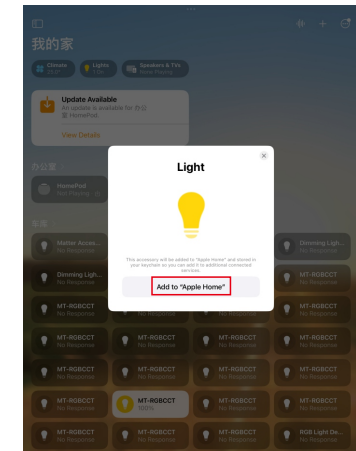

Figure 11

Step 3: Do wiring of the Matter LED controller according to the wiring diagram and power on it.

Step 4: Short press the Prog. button 5 times to set the LED controller into pairing mode.

Step 5: Add the Matter LED controller to the Apple Home app by scanning the QR code sticker on the LED controller as shown in **Figure 8** to **Figure 15**.

Note: before scanning the QR code sticker on the dimmer as shown in **Figure 10**, short press the Prog. button 5 times to set the LED controller into pairing mode so that it can be discovered by the Apple Home app. Otherwise it can not be discovered by the Apple Home App.

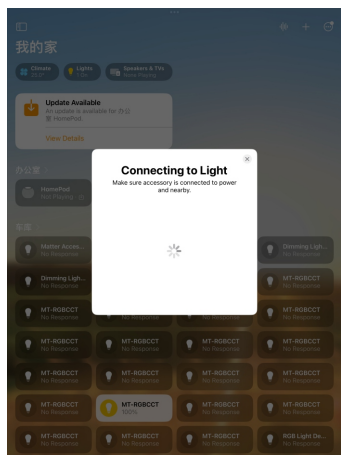

Figure 12

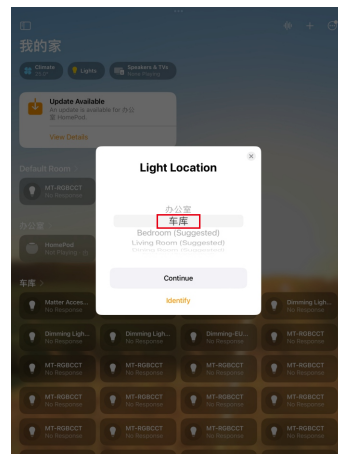

Figure 13

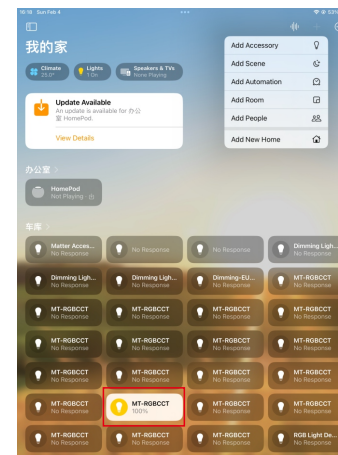

Figure 16

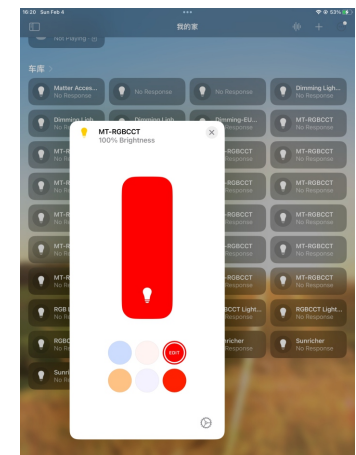

Figure 17

Step 6: once the LED controller is added to the border router successfully, tap on the device to control on/off, and press and hold device icon to enter into brightness and color control interface as shown in **Figure 16** to **Figure 17**.

4. Restore factory settings

To restore the factory settings, short press the “Prog.” button 5 times or switch the device power on and off in the following sequence.

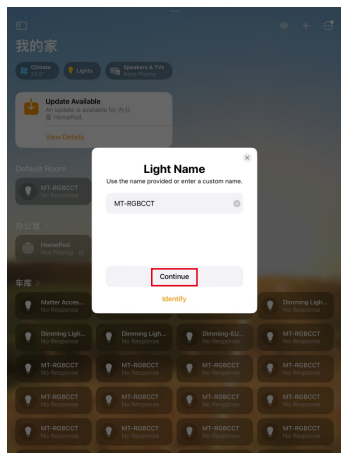
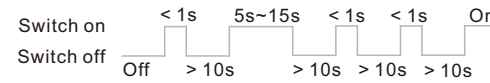

Figure 14

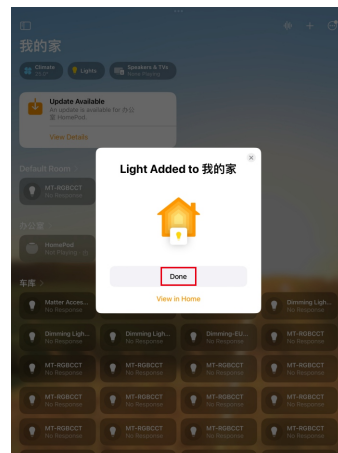
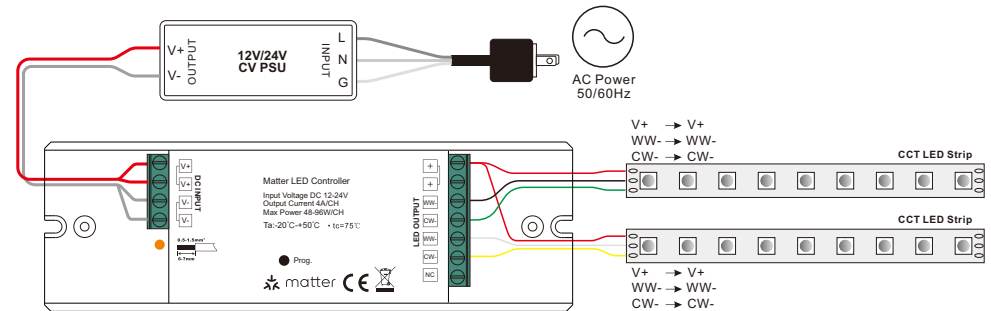

Figure 15

Note: when choose the room that you would like to add the LED controller to, please make sure to choose the same room that the HomePod mini is located as shown in **Figure 13**.

Wiring Diagram



Product Dimension

